



PELTOR™
Protection & Communication

3M™ PELTOR™

Tactical Modular Audio System

3M Science. Applied to life.™



PELTOR™
Protection & Communication

We strive to set the standard for confidence and trust by providing rugged, reliable protective communication equipment.

3M™ PELTOR™ Solutions for today's modern warfighter have been worn for use in combat and combat support operations and are compatible with most firearms and ballistic helmets. PELTOR headsets are known for their reliability in delivering critical radio communications in the heat of an operation. The hearing protectors feature external microphones for environmental listening (aka Talk-Through) capability, so operators can maintain auditory situational awareness while protecting their hearing.

With more than 70 years of experience, the 3M™ PELTOR™ Brand promises quality communication solutions that help provide an excellent balance of performance and protection.

The advanced engineering and technology inherent with the 3M™ PELTOR™ Brand fits with the high standard of quality and innovation of a continuously evolving range of product solutions that you, our customers, come to expect from 3M.

3M™ PELTOR™ Tactical Modular Audio System



3M™ PELTOR™
System Control Unit, SCU-300

3M™ PELTOR™
ComTac™ VII Headset

3M™ PELTOR™
Tactical Earplug, TEP-300

3M™ PELTOR™ Tactical Modular Audio System (TMAS), is 3M's newest generation of tactical communication and hearing protection, developed to help operators effectively communicate in dynamic noise environments.

The new system brings forward our next generation ComTac VII and TEP-300 with new looks, improved systems integration, and enhanced auditory situational awareness to help give operators a tactical edge during operations.

TMAS features wireless communication that removes the cable(s) between the headset and PTT (Push to talk), helping to increase overall mobility. Additionally, the system comes equipped with a new remote PTT, that

can be mounted on the weapons rail – giving operators the capability to transmit and adjust volume without having to remove their hand from the weapon.

The system offers flexibility and scalability to address the needs of the modern operator.

Welcome to the next generation of communication capability from 3M PELTOR.

3M™ PELTOR™ System Control Unit - SCU-300

Wireless or Wired

Utilizing near field magnetic induction, the 3M™ PELTOR™ System Control Unit helps to improve cable management through cord-free connection to the 3M™ PELTOR™ ComTac™ VII Headset, and 3M™ PELTOR™ Tactical Earplugs, TEP-300. There is also a port for an optional wired connection to the 3M™ PELTOR™ ComTac™ VII Headset.

Multiple Radios

The SCU is equipped with three com ports for radios and intercom systems, and is designed to handle multiple radios with multiple channels. In such scenarios, the user is able to select one of three preset sound profiles;

Mix:

The sound is heard equally in both left and right ear.

Surround:

The sound will be perceived as it is coming from different directions, depending on which channel the sound is transmitted from.

Single:

The sound will only be heard in one of the ears.

Wireless

Utilizing Near Field Magnetic Induction (NFMI) technology, the 3M™ PELTOR™ Tactical Modular Audio System lets you experience wireless freedom through a cable-free connection between the 3M™ PELTOR™ System Control Unit and the TEP-300 or ComTac™ VII Headsets. Near Field Magnetic Induction is a short range, digital, wireless physical layer that communicates by coupling a tight, low-power, non-propagating magnetic field between devices.

The range is approximately 50 cm (20 in).

The steep degradation of NFMI signal strength as a function of distance increases privacy and reduces issues with interference compared to traditional wireless technology.

The SCU is also available with Bluetooth® technology for those who also prefer a wireless connection to external devices.

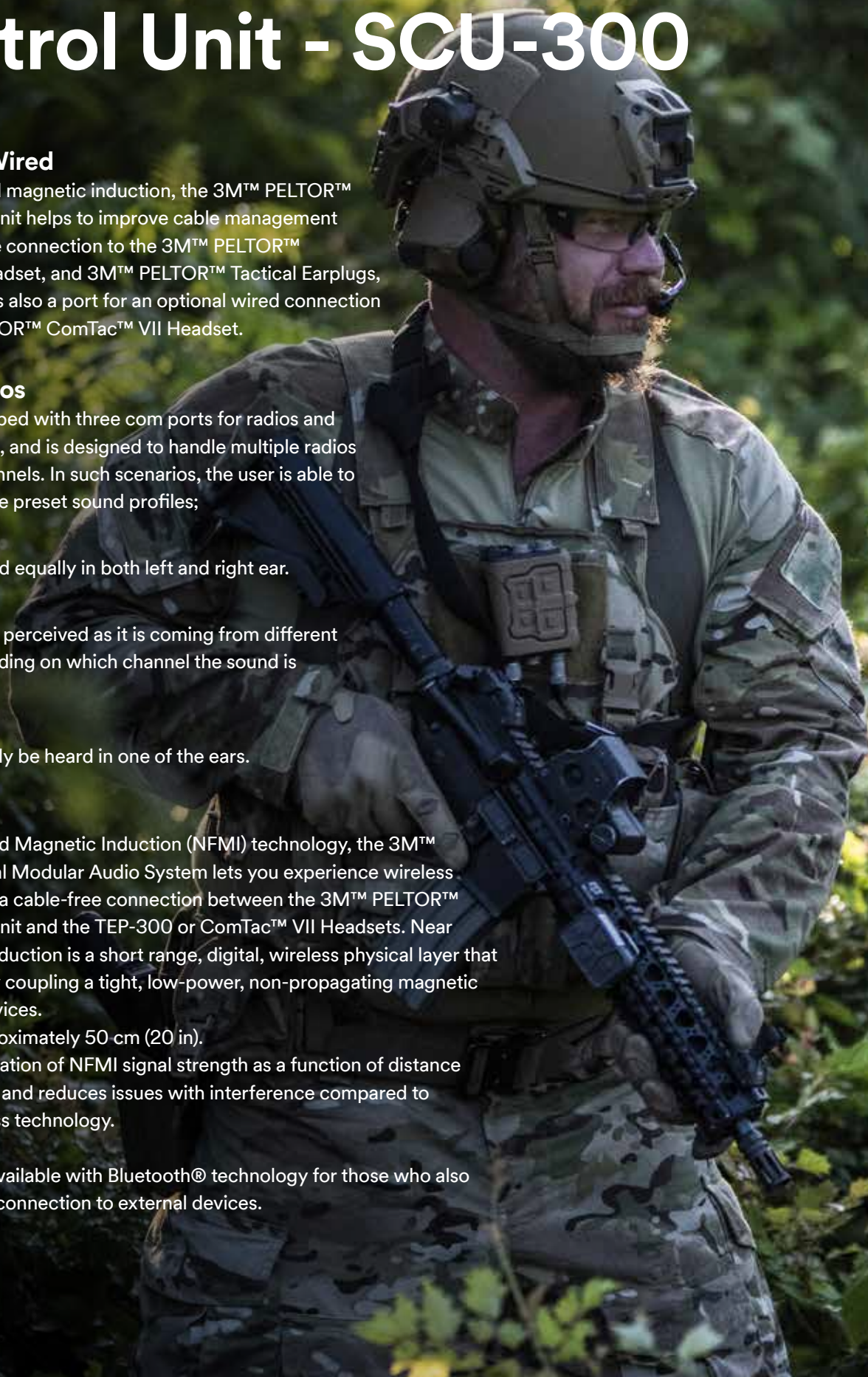

3M™ PELTOR™ System Control Unit, SCU-300 **

Wireless or Wired

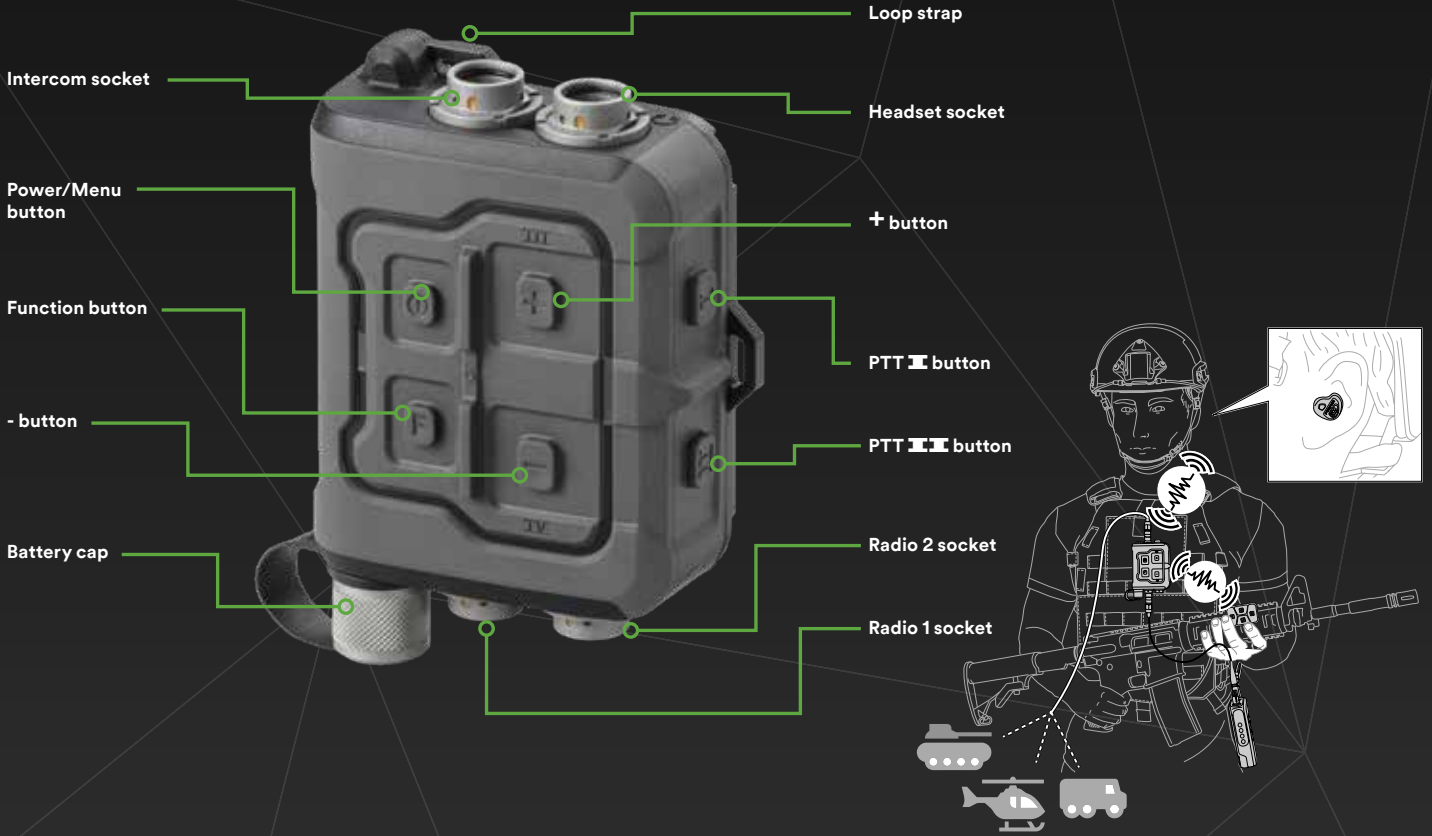

3M™ PELTOR™ Remote Control Unit, RCU-300 **

Wireless Remote Control Unit

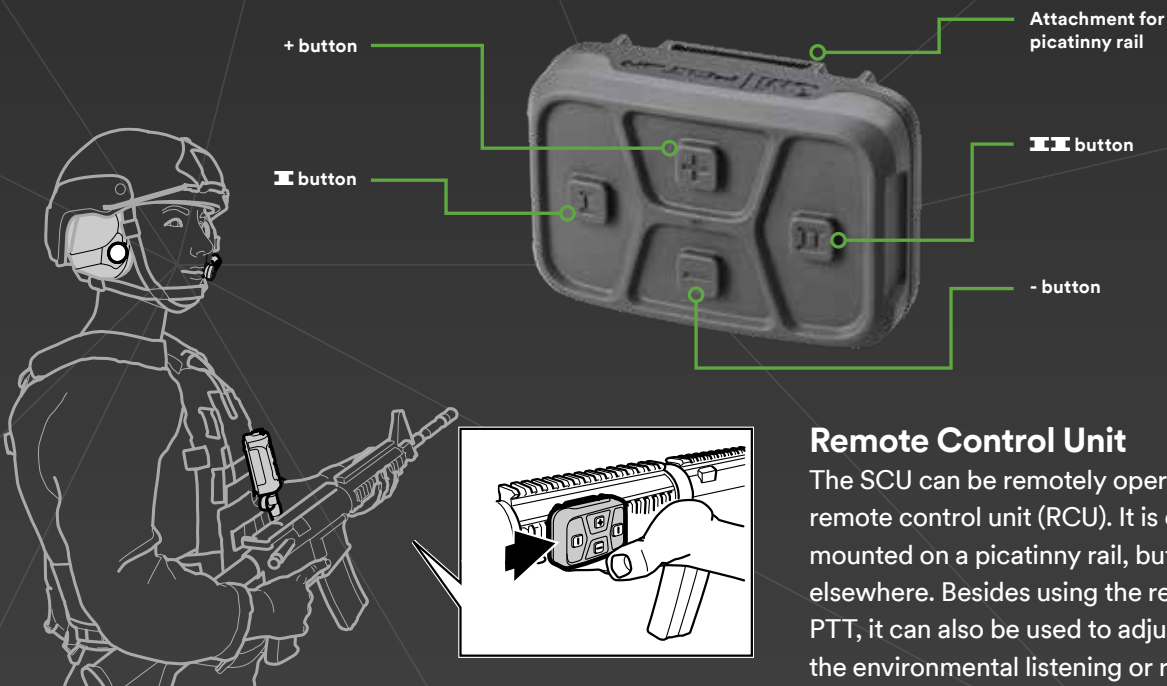

Remote Control Unit

The SCU can be remotely operated via a wireless remote control unit (RCU). It is designed to be mounted on a picatinny rail, but can be placed elsewhere. Besides using the remote as a push-to-talk PTT, it can also be used to adjust the volume level of the environmental listening or radio.

3M™ PELTOR™ ComTac™ VII Headset

New Cup & Headband Design

The new 3M™ PELTOR™ ComTac™ VII headset is designed to allow for dual hearing protection. It can be used in combination with 3M™ PELTOR™ TEP-300 earplugs, or passive earplugs.

A new headband design helps to make transition between rail mounted systems and headband eaiser. It can also help to improve comfort when worn under a ballistic helmet.

Rugged Microphone

The new speech microphone is redesigned and embedded with patented 3M closed cell foam, delivers improved noise cancelling transmission in high noise and wind while also improving dust and water ingress protection (IP68, 6m / 30 min).

The microphone attachment is designed to help accommodate both left handed and right handed shooters without the need to relocate the microphone to opposite side of the headset.

Environmental Microphones & Natural Interaction Behavior (NIB)

New design and wind screen attachment help to improve environmental listening.

Choose between classic mode, or advanced mode with 5 different Mission Audio Profiles (MAP); Silent, Observation, Patrol, Conversation or Comfort.

Natural Interaction Behaviour (NIB), helps to improve close range face-to-face communication in steady state noise environments.

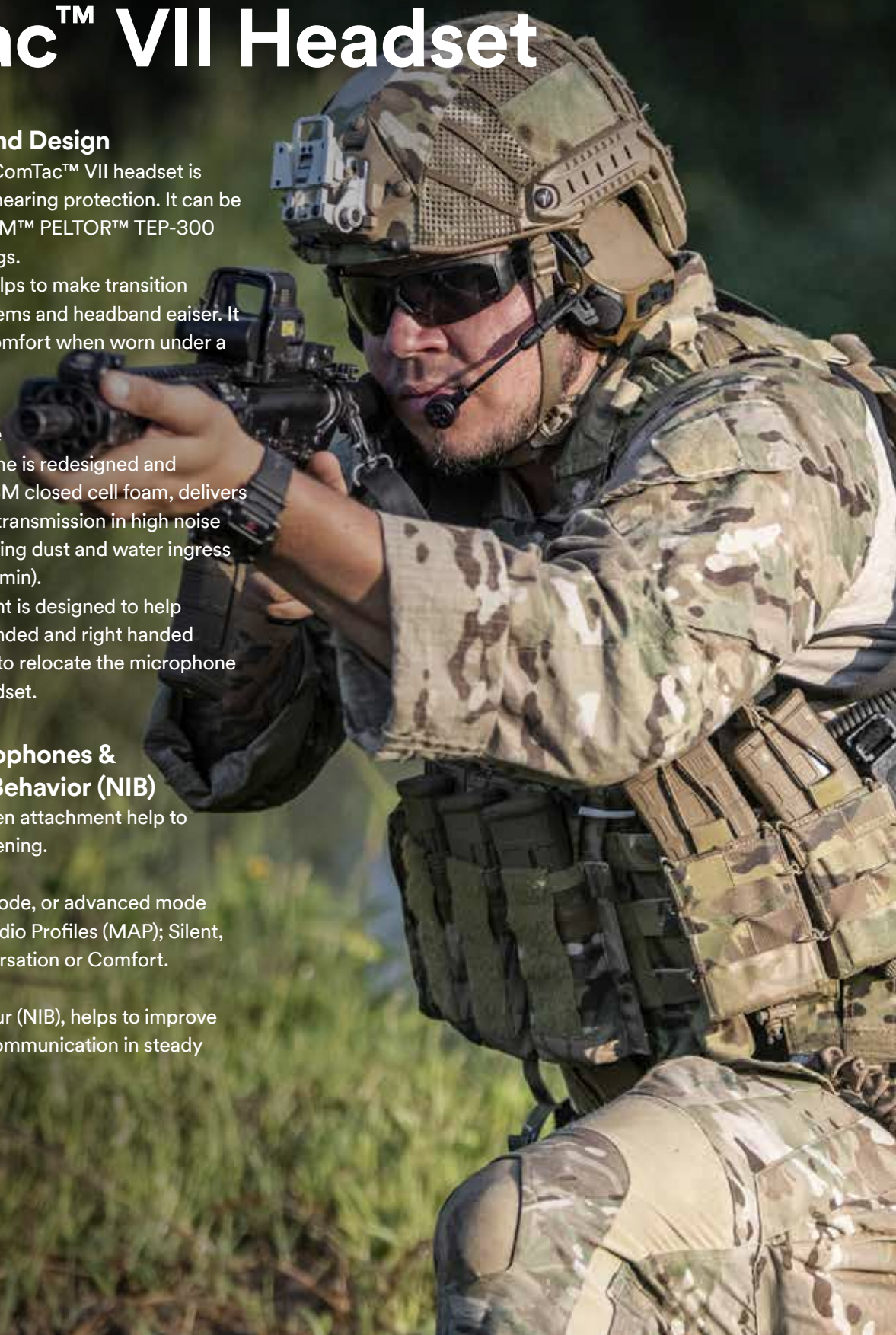

3M™ PELTOR™ ComTac™ VII Headset

Tactical Modular Headset

New Headband Design

Upgraded design for easy transition between rail mounted systems and headband, and to help improve comfort when worn under a ballistic helmet.

Dual Hearing Protection

Designed to enable use in combination with 3M™ PELTOR™ TEP-300 earplugs, or passive earplugs.

Speech Microphone

Redesigned and embedded with patented 3M closed cell foam, delivers improved noise cancelling transmission in high noise and wind while also improving dust and water ingress protection (IP68, 6m / 30 min).

Natural Interaction Behavior (NIB)

To help improve close range face-to-face communications in noise.

Near Field Magnetic Induction (NFMI)

Wireless connection to 3M™ PELTOR™ System control Units, SCU-300.

New Microphone Attachment

Designed to help accommodate both left handed and right handed shooters without the need to relocate the microphone to opposite side of the headset.

Environmental Listening Microphones

- Advanced Mode (MAP)
- Classic Mode

Detachable Download

A port for an optional wired connection to the 3M™ PELTOR™ System Control Unit, SCU-300.

Water tight battery compartment

Powered by 2 X AAA.
Does not require a tool to change batteries.



3M™ PELTOR™ ComTac™ VII Headset

Mission Audio Profiles (MAP)



The 3M™ PELTOR™ ComTac™ VII offers a new way to adjust the auditory settings of your headset for your mission. Traditionally, a headset has a set frequency response, and the operator can only increase or decrease the volume. The MAP function provides advanced environmental listening modes that allow access to a variety of gain settings, but with frequency shaping, to enhance auditory performance in five conditions. The MAP Profiles have been designed with a variety of combat and combat support operations in mind.

Advanced level dependent function for environmental listening



Mission Audio Profile 1: Observation

Highest volume and widest frequency response to maximize hearing when the user is still (overwatch, hide spot, stop to listen, etc).



Mission Audio Profile 2: Patrol

High volume with reduced high frequencies to limit sounds such as footsteps on gravel, grass moving under feet, equipment moving on body.



Mission Audio Profile 3: Conversation

Maximizes the frequencies important for face-to-face communications while lowering the frequencies outside of the average speech band.



Mission Audio Profile 4: Comfort

Low volume and narrow frequency response to be used when in noise for long periods of time (tactical vehicle, air transport) where environmental listening is not prioritized over communications and overall comfort.

Mission Audio Profile 5: Silent

Silent mode for communicating in high levels of noise when situational awareness is difficult to achieve

3M™ PELTOR™ ComTac™ VII Headset

Natural Interaction Behavior (NIB)



NIB offers electronic, headset-to-headset communication with a transmission range of ≈ 10 m/11 yd from the speaker. There is no limit regarding how many people within that transmission range that can receive the transmission.

Up to 4 users within ≈ 150 m/165 yd can transmit simultaneously using 1 of 4 open slots/channels. Once all 4 channels are active, no one else in the group can transmit until a channel becomes available. If a fifth person tries to transmit, a beeping sound will indicate that the message was not transmitted. This ≈ 150 m/165 yd range is in an open field (line in sight) and may be reduced by physical structures.

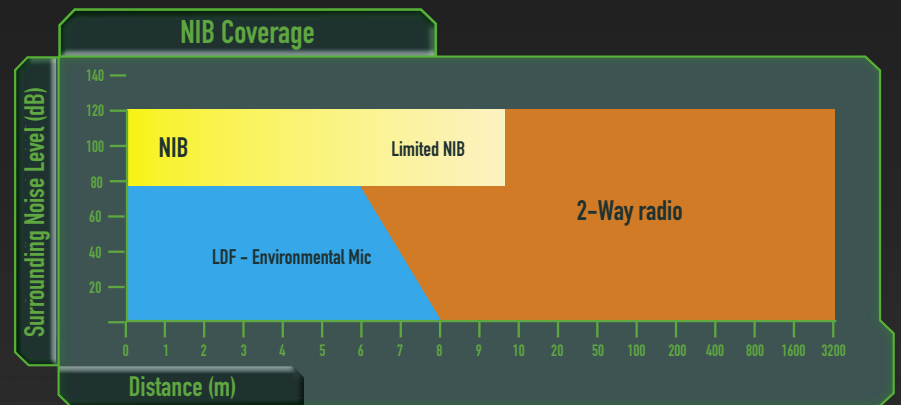

3M™ PELTOR™ Tactical EarPlug, TEP-300

Compact Hearing Protection

3M™ PELTOR™ Tactical Earplugs, features environmental listening function – a capability designed to help provide auditory situational awareness, while still helping provide protection from hazardous noise. It comes with multiple sizes and types of replaceable eartips, designed to help provide hearing protection. The small size makes 3M™ PELTOR™ Tactical Earplug compatible with most headborne Personal Protective Equipment (PPE) such as helmets, eye wear, and respirators.

In Ear Speech Microphone*

The TEP-300 features in-ear, acoustical, speech communications microphones which pick up sound waves from your voice as you speak. This design eliminates the need for a traditional boom microphone, making it easier to use in combination with respiratory equipment.

Portable Charging Case

3M™ PELTOR™ Tactical Earplugs, TEP-300 comes with a pocket-sized storage and charging container, which includes a charging status indicator. It provides up to 16 charges from 3 AA or AAA batteries (with adapter). A USB-C port also enables the charging of the earplugs when plugged into a usb power supply or other power source (cable not included).

*Speech intelligibility, using an in-ear microphone, may vary between different radio models, and from person to person.



3M™ PELTOR™ Tactical EarPlug, TEP-300

Compact Hearing Protection

Operation

Intuitive one-button operation turns unit on, off, and selects volume settings .

Rechargeable

Charging contacts recharge the unit while in the case. Internal earpiece Li-ion battery provides up to 10 hours of continuous operation when fully charged.

Hearing Protection

Replaceable communications eartip helps provide hearing protection in noisy environments. Multiple sizes and types designed to fit most ear canals.



Environmental Microphone Port

Assists with maintaining auditory awareness while helping minimize wind noise. Additional windscreen accessory available.

IP68 Water and Dust Resistant

Innovative design helps protect earpiece against water and dust ingress.

Near Field Magnetic Induction (NFI)

Wireless connection to 3M™ PELTOR™ System control Units, SCU-300.

In Ear Speech Microphone

The TEP-300 features an in ear speech microphones which picks up sound waves that come out of your ear as you speak

3M™ PELTOR™ Tactical EarPlug, TEP-300

Portable Charging Case

Portable Charging Compartment

Up to 16 recharging cycles with AA batteries.

Sealing Ring

Rubber sealing ring helps protect earplugs and charging case in wet and dirty environments. (IP68)



Charging Status LED

Led lights indicate charging status.

Micro USB-C Charging Port

USB port enables the charging of the earplugs when plugged into a computer or usb power supply (cable not included).

Earplug Clips

Steel clips help secure earplugs in case.

Dual Protection

In many scenarios, dual hearing protection may be required not only for protection, but to maintain clear communications. The 3M™ PELTOR™ Tactical Modular Audio System is designed to allow for dual hearing protection, to help provide additional attenuation when required. In dual protection mode, incoming audio is routed to the 3M™ PELTOR™ Tactical Earplug TEP-300 speakers, and outgoing transmission through the ComTac™ VII Speech Microphone.

The 3M™ PELTOR™ ComTac™ VII Headset can also be used in combination with passive ear plugs. In this case, situational awareness is maintained by boosting the volume of the environmental listening to help compensate for the additional attenuation provided by the earplugs.





Examples of headset configurations

Modular Design

The Tactical Modular Audio System allows for a multitude of setup options. There are several configuration options to accommodate different protection levels and radio scenarios.

STAND ALONE



WIRELESS / SCU



WIRED / SCU



STAND ALONE



WIRELESS / SCU

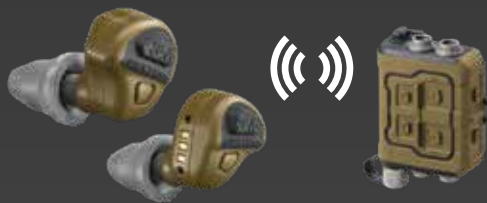

WIRELESS / SCU / DUAL PROTECTION



Examples of radio configurations

SINGLE RADIO, ONE CHANNEL

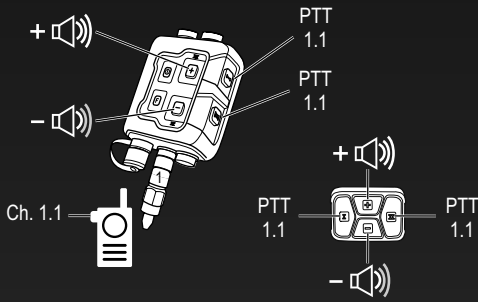

SINGLE RADIO, MULTIPLE RADIO CHANNELS

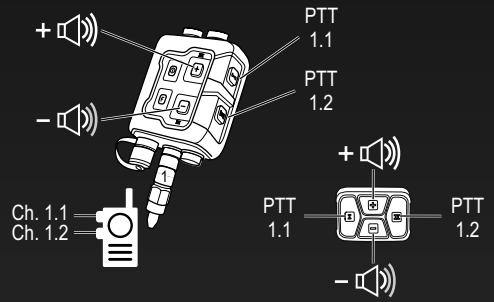

TWO RADIOS, ONE CHANNEL EACH

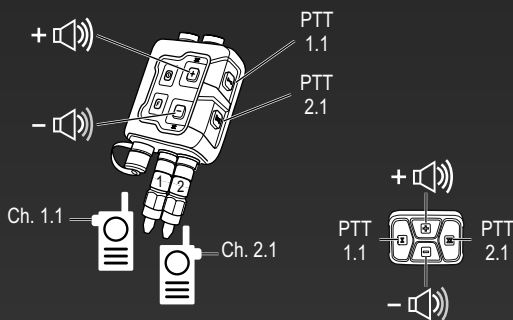

MULTIPLE RADIOS, MULTIPLE CHANNELS

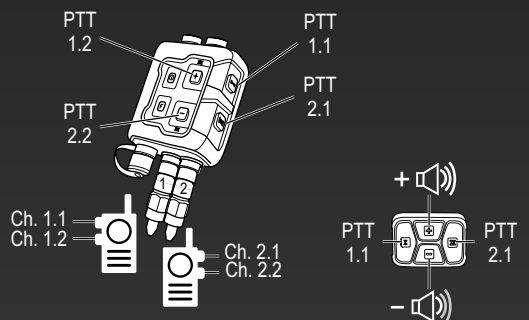

INTERCOM + TWO RADIOS, ONE CHANNEL

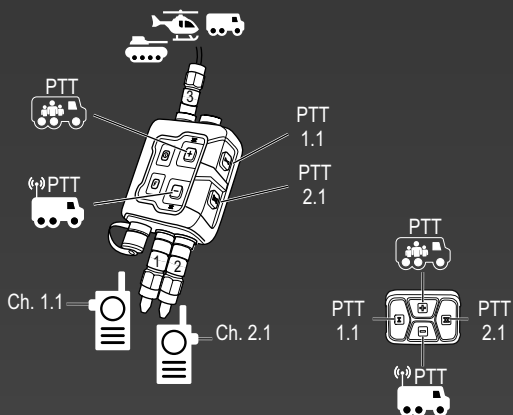

INTERCOM + TWO RADIOS, MULTIPLE RADIO CHANNELS

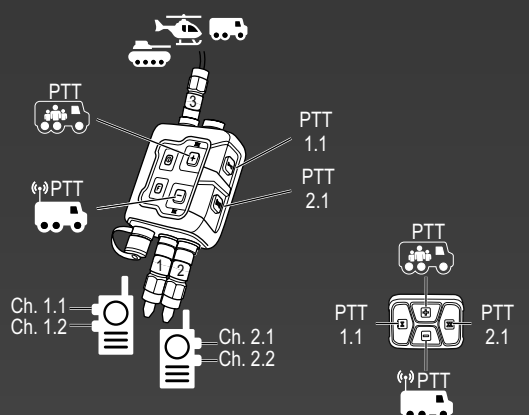

3M™ PELTOR™ System Control Unit, SCU-300

Performance Specifications & Ordering Information

Technical Specifications

SCU Power:

Battery Type:	2 x AAA
Operating time:	Approximately 30 hours

RCU Power:

Battery type:	Button cell
Operating time:	Approximately 1600 h

Bluetooth® Technology* :

Bluetooth version:	4.2
Bluetooth headset profile (HSP):	1.2
Bluetooth hands-free profile (HFP):	1.6
Bluetooth Range:	Up to 10m (class 2)

*Only applicable to SCU-300EU WS GE

Near Field Magnetic Induction (NFMI):

Transmission rate:	596 kbit/s
Range:	Approximately 50 cm
Frequency:	9.8 - 11.7Mhz

Environmental Characteristics:

Operating temp:	-20 to +55°C
Shelf Life:	5 years, excluding batteries
Waterproof Rating :	IP68 compliant

Physical Characteristics:

SCU Size:	L: 110mm W: 75mm H: 36mm
Weight:	218g
RCU Size:	L: 61mm W: 41mm H: 24mm
RCU Weight:	51g

Recommended Storage Conditions:

5 years:	In door controlled climate (<90% humidity)
----------	--

Military Approvals

Tested according to the applicable parts of MIL-STD-810G, EMC-MIL-STD-461G.

Environmental Performance:

Tested in accordance with MIL-STD-810G

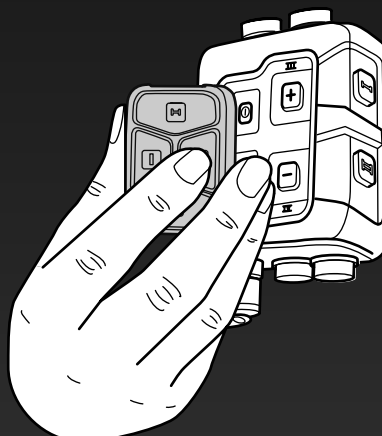



Standards and Approvals

3M Svenska AB declares that the Bluetooth® headset is in compliance with Directive 2014/53/EU and other appropriate directives to fulfill the requirements for the CE marking. The full text of the EU declaration of conformity is available at the following internet address: www.3M.com/peltor/doc



3M™ PELTOR™ System Control Unit, SCU-300

Part Number	Description	Legacy 3M ID	SAP ID	Color
SCU-300EU CY	3M™ PELTOR™ System Control Unit, Coyote Brown	UU010934899	7100223392	
SCU-300EU WS GE	3M™ PELTOR™ System Control Unit, Grey, Bluetooth®	UU010934816	7100224666	

Accessories & Spare parts - SCU-300

Part number	Description	Legacy 3M ID	SAP ID
RCU-300EU/1	3M™ PELTOR™ Remote Control Unit, RCU-300EU	UU010934915	7100224667
FE0344/1	3M™ PELTOR™ Spring steel bracket for RCU-300	UU010967618	7100226974
DE0408/1	3M™ PELTOR™ SCU-300 Battery cap	UU010967634	7100228540
TKD8003/1	3M™ PELTOR™ SCU attachment Clip	UU010965505	7100228539
DE0437/4	SCU dust cap	UU010958724	7100227470
DE0438/1	SCU cable dust cap	UU010955944	7100228566

Radio Cables - SCU-300

Part number	Description	Legacy 3M ID	SAP ID
SCU-FL001	HELICOPTER LOW IMPEDENCE	UU010965554	7100227473
SCU-FL002	LVIS EUR	-	-
SCU-FL003	MBITR MARITIME, 10 pin	-	-
SCU-FL006	AN/PRC-163	-	-
SCU-FL009	AN/VIC 3	-	-
SCU-FL030	MOTOROLA GP340	UU010965760	7100228538
SCU-FL040	MBITR, HARRIS 5800, LVIS USA	UU010965752	7100227451
SCU-FL042	NOKIA THR880	UU010958716	7100227351
SCU-FL052	THALES PR4G	UU010965745	7100227450
SCU-FL063	MOTOROLA MTRTRBO	UU010963666	7100228537
SCU-FL101	SEPURA STP	UU010963658	7100231760
SCU-FL090	Smartphone, 3,5 mm	UU010963641	7100228536
SCU-FL018	Motorola XTS1500 / HT1000	UU010958732	7100233149

* Modern military communication radios can have different configurations depending on how it is programmed. Users are advised to connect headsets and SCU to actual radio and configuration being used, in order to test functions and features before purchase.

Performance Specifications & Ordering Information

Technical Specifications

Speech Microphone Type:

Dynamic (MT71) waterproof (IP68), 6m / 30min

Power / Electrical Characteristics:

Battery Type: 2 x AAA
 Environmental listening: Approximately 50 hours
 Environmental & NIB: Approximately 30 hours

NIB™ Natural Interaction Behavior function :

Frequency band: 864 Mhz and 915 Mhz
 Operation mode: Full Duplex
 Range: **Approximately 3-5m:**
 Optimal for communication
Approximately 5-10m:
 Fade in and fade out
 Modulation: TDMA protocol

Near Field Magnetic Induction (NFMi):

Transmission rate: 596 kbit/s
 Range: approximately 50 cm (20 in)
 Frequency: 9.8 - 11.7Mhz

Physical Characteristics:

Weight with batteries: 326 gram (standard foam ring)
 361 gram (with gel ring)

Environmental Characteristics:

Operating temp: -20 to +55°C
 Shelf Life: **Headset:** 5 years, excluding batteries
 Waterproof Rating : **Salt water (5%)** 2m at 30 min

Recommended Storage Conditions (<90% humidity):

5 years: Indoor Controlled Climate (<90% humidity)

Military Approvals

Tested according to the applicable parts of MIL-STD-810G, EMC-MIL-STD-461G.

Environmental Performance:

Tested in accordance with MIL-STD-810G

Standards and Approvals

Hereby, 3M Svenska AB declares that the product is in compliance with appropriate directives or regulations to fulfill the requirements for the CE marking. The full text of the EU declaration of conformity is available at the following internet address: www.3M.com/PELTOR/DOC.

A copy of the declaration of conformity and additional information required in the directives or regulations can also be obtained by contacting 3M in the country of purchase.

Approvals

PPE Regulation 2016/425
 EMC Directive 2014/30/EU
 ROHS Directive 2011/65/EU
 Radio Directive 2014/30/EU
 RED Directive 2014/53/EU

Laboratory Attenuation Values ***

MT14H41A-300EU CY

EN:352-1

Frequency (Hz) ²	125	250	500	1000	2000	4000	8000
Mean Attenuation (dB) ³	12.6	18.1	29.1	30.5	31.9	43.7	39.4
Standard Deviation (dB) ⁴	2.3	1.5	3.3	2.6	2.2	2.5	2.7
Assumed Protection Value (dB) ⁵	10.3	16.6	25.8	27.9	29.7	41.2	36.7

SNR=29 dB H=32 dB M=26 dB L=18 dB

MT14H41A-300EU CY with Gel rings (HY80-EU)

EN:352-1

Frequency (Hz) ²	125	250	500	1000	2000	4000	8000
Mean Attenuation (dB) ³	12.1	17.8	29.2	34.9	33.9	43.2	39.3
Standard Deviation (dB) ⁴	2.2	1.4	2.9	2.2	2.2	3.2	3.3
Assumed Protection Value (dB) ⁵	9.9	16.4	26.3	32.7	31.7	40.0	36.0

SNR=29 dB H=34 dB M=26 dB L=18 dB

***3M strongly recommends personal fit testing of hearing protectors. Research suggests that users may receive less noise reduction than indicated by the attenuation label value(s) on the packaging due to variation in fit, fitting skill, and motivation of the user. Refer to applicable regulations for guidance on how to adjust attenuation label values. In the absence of applicable regulations, it is recommended that the SNR be reduced to better estimate typical workplace protection.

Models - 3M™ PELTOR™ ComTac™ VII



Part Number	Description	Legacy 3M ID	SAP ID	Color
MT14H41A-300EU CY	3M™ PELTOR™ ComTac VII, Coyote Brown	UU010934865	7100222871	
MT14H41A-300EU GE	3M™ PELTOR™ ComTac VII, Grey	UU010934881	7100222909	
MT14H41A-300EU GN	3M™ PELTOR™ ComTac VII, OD Green	UU010934873	7100222859	

Accessories & Spare parts - ComTac VII

Part number	Description	Legacy 3M ID	SAP ID
M194/2	3M™ PELTOR™ Wind shield Kit for surround mic	UU010955936	7100232688
1086 SV/1	3M™ PELTOR™ Battery Lid	UU010953469	7100232689
AL8002/1	3M™ PELTOR™ Downlead cable ComTac™ VII	UU010954111	7100225790
AGM/1	3M™ PELTOR™ Headband ComTac™ VII	UU010972220	7100227486
A47/1	3M™ PELTOR™ Microphone guide	UU010972238	7100227492
MT71/1	3M™ PELTOR™ Boom Microphone dyn	UU010972246	7100230581
P3ADG47-F SV/2	3M™ PELTOR™ ARC rail attachment, 1 pair	UU010972253	7100227493
HY80-EU	3M™ PELTOR™ Gel Sealing Rings for ComTac™	UU003133988	7100101182
HY68 SV	3M™ PELTOR™ Hygiene Kit standard for ComTac™	XH001659461	7000108023
HYM1000	3M™ PELTOR™ Micprotector, 5m, black	XH001651328	7100064281
M171/2	3M™ PELTOR™ Windshield for MT71/1 mic	UU008153483	7100112112
M42/1	3M™ PELTOR™ Windshield MAXI for dyn mic	XH001659792	7000039687

3M™ PELTOR™ Tactical EarPlug, TEP-300

Performance Specifications & Ordering Information

Technical Specifications

Speech Microphone Type:

In Ear

Power / Electrical Characteristics:

Earplug Battery Type:	Lithium Ion
Operating time:	Approximately 10 hours
Earplug Battery Charge Time:	Approximately 60 minutes
Case Battery Type:	3 AA or AAA Alkaline Batteries (with adapter)
Case Battery Life:	Up to 16 recharging cycles with AA batteries
Case USB Type:	Micro C 3.1

Near Field Magnetic Induction (NFMI):

Transmission rate:	596 kbit/s
Range:	approximately 50 cm (20 in)
Frequency:	9.8 - 11.7Mhz

Physical Characteristics:

Case Size (L x W x H):	114.2 mm x 78.2 mm x 29 mm
Case Material:	ABS
Weight Charger with batteries, 2 earpieces:	188 g
Weight Charger:	104 g
Weight 1 earplug:	4,7 g

Environmental Characteristics:

Earpiece operating temp:	-20 to +50°C
Charger operating temp:	0 to +45°C
Shelf Life:	Max 12 months
Waterproof Rating :	Earpiece and Case (with lid and USB port securely closed) are IP68 compliant

Recommended Storage Conditions (<90% humidity):

1 year:	-20 to +20°C
3 months:	-20 to +45°C
1 month:	-20 to +60°C

Military Approvals

Tested according to the applicable parts of MIL-STD-810G,
EMC-MIL-STD-461G.

Environmental Performance:

Tested in accordance with MIL-STD-810G

Standards and Approvals

Hereby, 3M Svenska AB declares that the product is in compliance with appropriate directives or regulations to fulfill the requirements for the CE marking. The full text of the EU declaration of conformity is available at the following internet address: www.3M.com/PELTOR/DOC.

A copy of the declaration of conformity and additional information required in the directives or regulations can also be obtained by contacting 3M in the country of purchase.

Approvals

PPE Regulation 2016/425
EMC Directive 2014/30/EU
ROHS Directive 2011/65/EU
Radio Directive 2014/30/EU
RED Directive 2014/53/EU

Laboratory Attenuation Values*** EN 352-2:2002

3M™ PELTOR™ CCC-GRM-25 Communication Eartips

Frequency (Hz) ²	125	250	500	1000	2000	4000	8000
Mean Attenuation (dB) ³	35.1	32.5	37.5	37.9	37.1	40.8	44.6
Standard Deviation (dB) ⁴	5.5	4.9	5.1	4.8	4.3	4.6	4.7
Assumed Protection Value (dB) ⁵	29.6	27.6	32.3	33.2	32.9	36.2	39.9

SNR=35 dB H=34 dB M=33 dB L=31 dB

3M™ Torque™ Communication Eartips

Frequency (Hz) ²	125	250	500	1000	2000	4000	8000
Mean Attenuation (dB) ³	38.1	35.5	40.7	40.9	37.5	40.3	44.9
Standard Deviation (dB) ⁴	5.4	5.4	5.7	5.8	3.2	3.3	4.2
Assumed Protection Value (dB) ⁵	32.7	30.1	35.0	35.1	34.3	37.0	40.7

SNR=37 dB H=36 dB M=35 dB L=33 dB

3M™ UltraFit™ Communication Eartips

Frequency (Hz) ²	125	250	500	1000	2000	4000	8000
Mean Attenuation (dB) ³	32.8	30.2	31.6	31.2	33.0	34.4	37.9
Standard Deviation (dB) ⁴	6.2	4.5	5.4	4.4	4.0	4.8	3.9
Assumed Protection Value (dB) ⁵	26.5	25.7	26.2	26.8	29.0	29.6	34.0

SNR=30 dB H=29 dB M=27 dB L=27 dB

***3M strongly recommends personal fit testing of hearing protectors. Research suggests that users may receive less noise reduction than indicated by the attenuation label value(s) on the packaging due to variation in fit, fitting skill, and motivation of the user. Refer to applicable regulations for guidance on how to adjust attenuation label values. In the absence of applicable regulations, it is recommended that the SNR be reduced to better estimate typical workplace protection.



Models - 3M™ PELTOR™ TEP-300

Part Number	Description	Legacy 3M ID	SAP ID	Color
TEP-300 EU CY	3M™ PELTOR™ Tactical Earplug, TEP-300 CY, Coyote Brown	70-0717-3430-8	7100227628	
TEP-300 EU GE	3M™ PELTOR™ Tactical Earplug, TEP-300 GE, Grey	70-0717-3427-4	7100227651	
TEP-300 EU TN	3M™ PELTOR™ Tactical Earplug, TEP-300 TN, Tan	70-0717-3426-6	7100227629	

Accessories & Spare parts - TEP-300

Part number	Description	Legacy 3M ID	SAP ID
TEP-300R CY	3M™ PELTOR™ Replacement Earplug, TEP-300R CY, Right, Coyote Brown	70-0717-3433-2	7100227632
TEP-300L CY	3M™ PELTOR™ Replacement Earplug, TEP-300L CY, Left, Coyote Brown	70-0717-3441-5	7100227644
TEP-300R TN	3M™ PELTOR™ Replacement Earplug, TEP-300R TN, Right, Tan	70-0717-3440-7	7100227649
TEP-300L TN	3M™ PELTOR™ Replacement Earplug, TEP-300L TN, Left, Tan	70-0717-3439-9	7100227647
TEP-300R GE	3M™ PELTOR™ Replacement Earplug, TEP-300R GE, Right, Grey	70-0717-3438-1	7100227648
TEP-300L GE	3M™ PELTOR™ Replacement Earplug, TEP-300L GE, Left, Grey	70-0717-3437-3	7100227645
TEP-300C GE	3M™ PELTOR™ Replacement Case, TEP-300C GE, Grey	70-0717-3436-5	7100227638
TEP-300C CY	3M™ PELTOR™ Replacement Case, TEP-300C CY, Coyote Brown	70-0717-3435-7	7100227630
TEP-300AD	3M™ PELTOR™ TEP-300AD, Battery adapter AAA	70-0717-3434-0	7100227631
CCC-GRM-25	3M™ PELTOR™ Communication Tip, Triple C, 25 pairs	70-0716-7521-2	7100103087
370-TEPL-25	3M™ UltraFit Communication Tips Replacement, Large, 25 pairs	70-0716-7374-6	7100066388
370-TEPM-25	3M™ UltraFit Communication Tips Replacement, Medium, 25 pairs	70-0716-7373-8	7100066387
370-TEPS-25	3M™ UltraFit Communication Tips Replacement, Small, 25 pairs	70-0716-7372-0	7100066371
PELTIP5-01	3M™ Torque™ Eartips, 50 pairs	XH0011679626	7000108492
TEP-CORD	3M™ LEP/TEP/EEP Cord	70-0716-7379-5	7100074090





Shoot, move and communicate.

To be an effective combat unit, each team member must be able to shoot, move and communicate seamlessly in chaotic environments. Communication being of the utmost importance.



3M Personal Safety Division
3M Svenska AB
Box 2341
SE-331 02 Värnamo, Sweden

Internet: www.3M.com

3M PSD products are for occupational use only.
Please recycle. Printed in Sweden. © 3M 2020. All rights reserved.
The Bluetooth® word mark and logos are registered trademarks owned by Bluetooth SIG, Inc. and any use of such marks by 3M Company is under license. 3M, PELTOR and ComTac are trademarks of 3M Company, used under license in Canada.

3M acknowledges the respective Trademark Owners' rights in this literature.

CAUTION:

When worn according to these User Instructions, these hearing protectors help reduce exposure to both continuous noises, such as industrial noises and noises from vehicles and aircraft, as well as very loud impulse noises, such as gunfire. It is difficult to predict the required and/or actual hearing protection obtained during exposure to impulse noises. For gunfire, the weapon type, number of rounds fired, proper selection, fit and use of hearing protection, proper care of hearing protection, and other variables will impact performance.
To learn more about hearing protection for impulse noise, visit www.3M.com/hearing.

 [www.Facebook.com/3mpeltor](https://www.facebook.com/3mpeltor)

 [@3mpeltor](https://www.instagram.com/3mpeltor)

 [www.Youtube.com/3mpeltor](https://www.youtube.com/3mpeltor)